

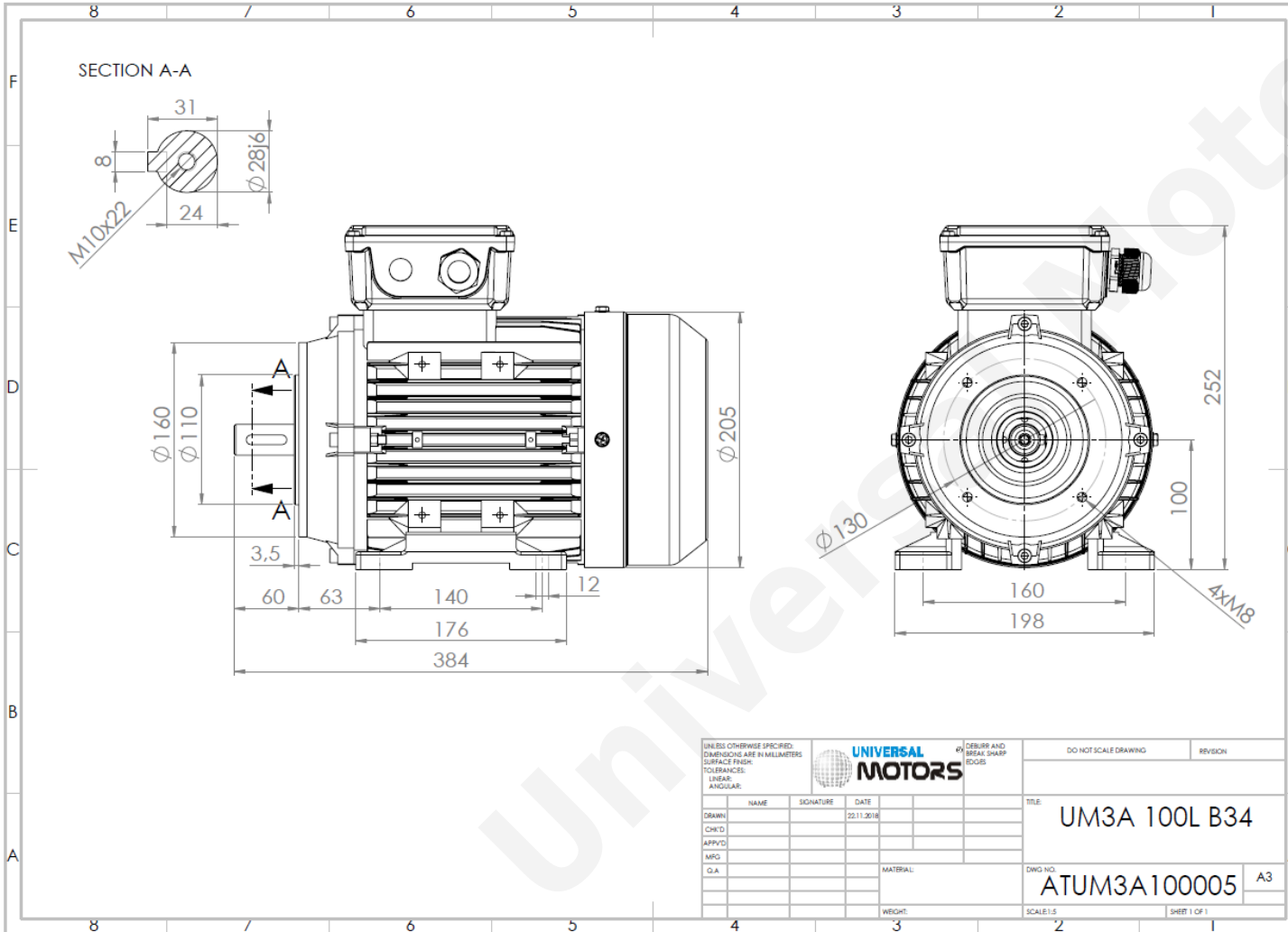

TECHNICAL DATA

Three Phase Electric Motors - Aluminum Frame
 PE31 100L-6
 1.5 kW / 2.0 Cv
 955 RPM



Motor type:	PE31 100L-6
Output:	1.5 kW / 2.0 Cv
Speed (min ⁻¹):	955 RPM
Frequency:	50 Hz
Voltage:	400 V
Current:	3.6 A
Power factor (Cos Ø):	0.74
Poles:	6
Insulation class:	F
Temperature rise Class:	B
Efficiency 50%:	80.4 %
Efficiency 75%:	83.0 %
Efficiency 100%:	82.5 %
Torque:	15.0 N.m
Tstarting/Tnominal:	2.1
Istarting/Inominal:	60.0
Tmaximum/Tnominal:	2.1
Noise:	61 Db(A)
Weight:	27.0 Kg
Bearing DE:	6206 2Z C3
Bearing NDE:	6206 2Z C3

Regime - S1

Altitude - 1000m

Environment Temperature - 40°C

CONTACTS:

UNIVERSAL MOTORS Tel: +351 252 299 080
 Rua de São Brás,745 Fax: +351 252 299 089
 4480-782 VILA DO CONDE Mail: geral@universalmotors.pt

* References applied only in the UK